

2018 International Swimming Pool and Spa Code

ORDINANCE NO. 1216

AN ORDINANCE ADOPTING THE INTERNATIONAL SWIMMING POOL AND SPA CODE, 2018 EDITION REGULATING THE CONSTRUCTION, ALTERATION, MOVEMENT, RENOVATION, REPLACEMENT, REPAIR AND MAINTENANCE OF AQUATIC RECREATION FACILITIES, POOLS AND SPAS IN THE CITY OF SOUTHLAKE; PROVIDING FOR THE ADOPTION OF LOCAL AMENDMENTS THERETO; PROVIDING FOR RECORDING OF SUCH CODE AS A PUBLIC RECORD; PROVIDING THAT THIS ORDINANCE SHALL BE CUMULATIVE OF ALL ORDINANCES; PROVIDING A SEVERABILITY CLAUSE; PROVIDING A SAVINGS CLAUSE; PROVIDING FOR PUBLICATION IN PAMPHLET FORM; PROVIDING FOR PUBLICATION IN THE OFFICIAL NEWSPAPER; AND PROVIDING AN EFFECTIVE DATE.

WHEREAS, the City of Southlake, Texas is a home rule city acting under its charter adopted by the electorate pursuant to Article XI, Section 5 of the Texas Constitution and Chapter 9 of the Local Government Code; and

WHEREAS, the City Council of the City of Southlake deems it necessary to adopt this ordinance governing requirements for the installation and maintenance of Heating, Air Conditioning and other Mechanical systems including requirements for materials, in order to protect the health, safety and welfare of the citizens of the City of Southlake.

WHEREAS, beginning in the spring of 2018, NCTCOG's Regional Codes Coordinating Committee (RCCC) and its five advisory boards conducted open review meetings over a one-year period to review the 2018 editions of the International Codes and to develop regional amendments. Their review and recommendations were completed and endorsed by NCTCOG's Executive Board on September 27, 2018. Now NCTCOG encourages jurisdictions in North Central Texas to adopt the 2018 International Swimming Pool and Spa Code along with its respective regional amendments.

NOW, THEREFORE, BE IT ORDAINED BY THE CITY COUNCIL OF THE CITY OF SOUTHLAKE, TEXAS:

**Section 1
Adoption**

That the International Swimming Pool and Spa Code, 2018 Edition, published by the International Code Council, is hereby adopted as the Swimming Pool and Spa Code of the City of Southlake. A True and correct copy of this document is referenced in Exhibit "A."

**Section 2
Amendments**

That the 2018 International Swimming Pool and Spa Code, as adopted herein, is hereby amended as provided in Exhibit "B" incorporated herein and attached hereto for all purposes of this ordinance. The City of Southlake may from time to time determine that additional local modifications to the 2018 International Swimming Pool and Spa Code are necessary and appropriate to meet the unique construction needs of the City of Southlake. To effectuate these modifications, the City council shall enact individual ordinances amending this ordinance fully setting forth the change to be made in the code. The amendments shall be consolidated as Exhibit "B" to this ordinance.

**Section 3
Recording**

The material contained in Exhibits "A" and "B" to this ordinance shall not be included in the formal municipal codification of ordinances, but shall be maintained as a public record in the office of the City Secretary and/or the office of Building Inspections and will be available for public inspection and copying during regular business hours.

**Section 4
Cumulative Clause**

This ordinance shall be cumulative of all provisions of ordinances of the City of Southlake, Texas, except where the provisions of this ordinance are in direct conflict with the provisions of such ordinances, in which event the conflicting provisions of such ordinances are hereby repealed.

**Section 5
Severability**

It is hereby declared to be the intention of the City Council that the phrases, clauses, sentences, paragraphs and sections of this ordinance are severable, and if any phrase, clause, sentence, paragraph or section of this ordinance shall be declared unconstitutional by the valid judgment or decree of any court of competent jurisdiction, such unconstitutionality shall not affect any of the remaining phrases, clauses, sentences, paragraphs and sections of this ordinance, since the same would have been enacted by the City council without the incorporation in this ordinance of any such unconstitutional phrase, clause, sentence, paragraph or section.

**Section 6
Penalty**

Any person, firm or corporation who violates, disobeys, omits, neglects or refuses to comply with or who resists the enforcement of any of the provisions of this ordinance shall be fined not more than Two Thousand Dollars (\$2,000.00) all violations involving zoning, fire safety or public health and sanitation, including dumping or refuse, and shall be fined not more than five hundred dollars (\$500) for all other violations of this ordinance each day that a violation is permitted to exist shall constitute a separate offense.

**Section 7
Saving Clause**

All rights and remedies of the City of Southlake are expressly saved as to any and all violations of the provisions of any ordinances affecting the installation and maintenance of pool, spa and other systems which have accrued at the time of the effective date of this ordinance; and, as to such accrued violations and all pending litigation, both civil and criminal, whether pending in court or not, under such ordinances, same shall not be affected by this ordinance but may be prosecuted until final disposition by the courts.

**Section 8
Publication**

The City Secretary of the City of Southlake is hereby authorized to publish this ordinance in book or pamphlet form for general distribution among the public, and the operative provisions of this ordinance as so published shall be admissible in evidence in all courts without further proof than the production thereof.

The City Secretary of the City of Southlake is hereby directed to publish in the official newspaper the City of Southlake, the caption, penalty clause, publication clause and effective date of this ordinance one time within ten days after passage of this ordinance, as required by Section 3.13 of the Charter of the City of Southlake.

**Section 10
Effective Date**

This ordinance shall be in full force and effect from and after its passage and publication as required by law but not before May 1, 2019.

APPROVED ON FIRST READING THIS 2 DAY OF APRIL, 2019.

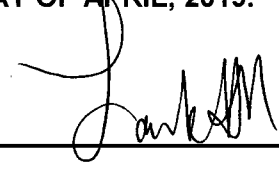

 _____ MAYOR

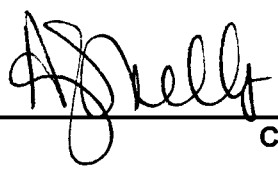
 ATTEST:

 _____ CITY SECRETARY

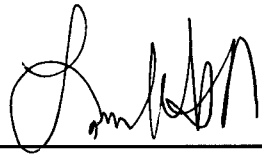
APPROVED ON SECOND READING THIS 16 DAY OF APRIL, 2019.

 _____ MAYOR

 ATTEST:

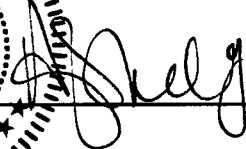
 _____ CITY SECRETARY

APPROVED AS TO FORM AND LEGALITY:



 CITY ATTORNEY

PUBLISHED: 4/19/19

EFFECTIVE: 4/20/19

EXHIBIT A

2018 International Swimming Pool and Spa Code Complete Edition

Located in the Building Inspections Office
1400 Main St., Suite 250
City of Southlake, Texas
76092

EXHIBIT B

2018 International Swimming Pool and Spa Code

The following sections, paragraphs, and sentences of the *2018 International Swimming Pool and Spa Code* are hereby amended as follows: Standard type is text from the ISPSC. Underlined type is text inserted. ~~Lined through type is deleted text from ISPSC.~~ A triple asterisk (***) identifies a new or revised amendment with the 2018 ISPSC code.

****Section 102.9; Change to read as follows:**

Section 102.9 Other laws. The provisions of this code shall not be deemed to nullify any provisions of local, state or federal law, to include but not limited to:

1. Texas Department of State Health Services (TDSHS); *Standards for Public Pools and Spas*; §285.181 through §285.208, (TDSHS rules do not apply to pools serving one- and two family dwellings or townhouses).
2. Texas Department of Licensing and Regulation (TDLR); *2012 Texas Accessibility Standards (TAS)*, TAS provide the scoping and technical requirements for accessibility for Swimming Pool, wading pools and spas and shall comply with *2012 TAS, Section 242*. (TAS rules do not apply to pools serving one- and two family dwellings or townhouses).

Exception: Elements regulated under Texas Department of Licensing and Regulation (TDLR) and built in accordance with TDLR approved plans, including any variances or waivers granted by the TDLR, shall be deemed to be in compliance with the requirements of this Chapter.

(Reason: To clarify specific Texas statutes which regulate public pools and spas.)

****Section 103.1; Change to read as follows:**

Section 103.1 Creation of enforcement agency. ~~The Department of Building Safety City of Southlake Building Inspections~~ is hereby created and the official in charge thereof shall be known as the *code official*. Tarrant County Health Department is hereby created and the official in charge thereof shall be known as the *code official* for operation and maintenance of any *public swimming pool* in accordance this code, local and state law.

(Reason: Reminder to be sure ordinance reads the same as designed by the City & the operation of public pools is enforced through the City's appropriate department procedure.)

****Section 107.4; Violation penalties. Delete entirely (covered by general provisions in Code of Ordinances):**

(Reason: Covered by general provisions of the Code of Ordinances.)

****107.5; Change to read as follows:**

107.5 Stop work orders. Upon notice...*{Text unchanged}* ... Any person who shall continue any work in or about the structure after having been served with a stop work order, except such work as that person is directed to perform to remove a violation or unsafe condition, shall be in violation of this code, liable to a fine of not less than [AMOUNT] dollars or more than [AMOUNT] dollars.

(Reason: Covered by general provisions of the Municipal Code of Ordinances.)

****Section 202; DEFINITIONS; insert definition; change to read as follows:**

TARRANT COUNTY HEALTH DEPARTMENT regulates the operation of public pools. Routine inspections on pools and spas open to the public are conducted to document compliance with the standards set forth in State law.

(Reason: The operation of public pools is enforced through **Tarrant County Health Department** procedures.)

*****Section 305; Change to read as follows:**

305.1 General.

The provisions of this section shall apply to the design of barriers for restricting entry into areas having pools and spas. In one-and two-family dwellings and townhouses, where spas or hot tubs are equipped with a lockable safety cover complying with ASTM F1346 and swimming pools are equipped with a powered safety cover that complies with ASTM F1346, the areas where those spas, hot tubs or pools are located shall not be required to comply with Sections 305.2 through 305.7.

(Reason: To clarify requirements for dwellings and commercial properties and specific Texas statutes which regulate public pools and spas.)

****Section 305.2; Change to read as follows:**

305.2 Outdoor swimming pools and spas. Outdoor pools and spas and indoor swimming pools shall be surrounded by a barrier that complies with Sections 305.2.1 through 305.7 and in accordance with the Texas Administrative Code, Texas Health and Safety Code 757 for public pools.

(Reason: To clarify specific Texas statutes which regulate public pools and spas.)

****Section 305.2.7. Add subsection 305.2.7.1; to read as follows:**

305.2.7.1 Chain link fencing prohibited. Chain link fencing is not permitted as a barrier in public pools built after January 1, 1994.

(Reason: To clarify specific Texas Health and Safety Code Chapter 757.003 (f).)

****Section 305.4 structure wall as a barrier; Changes as follows:**

305.4 Structure wall as a barrier. Where a wall of ~~a dwelling or structure~~ of a one and two family dwelling or townhouse or its accessory structure serves as part of a barrier and where doors or windows provide direct access to the pool or spa through that wall, one of the following shall be required:

1. Remainder Unchanged
2. Remainder Unchanged
3. Remainder Unchanged

The wall of a building with windows in accordance with 2018 International Building Code, Section 1030 in Group R2 occupancies shall not be used as part of pool enclosure. Other windows that are part of a pool yard enclosure shall be permanently closed and unable to be opened for public pools.

(Reason: To clarify specific Texas Health and Safety Code Chapter 757.007 & 2015 IBC, Section 1030.)

****Section 305.6; Change to read as follows:**

305.6 Natural barriers used in a one and two family dwelling or townhouse. In the case where the pool or spa area abuts ...*{Text unchanged}*

(Reason: Specific Texas statutes do not allow the use of natural barriers in lieu of fencing for public pools per Chapter 757.003).

****Section 307.1.4 Accessibility; Add exception to Section to 307.1.4 as follows:**

Exception: Components of projects regulated by and registered with Architectural Barriers Division of Texas Department of Licensing and Regulation shall be deemed to be in compliance with the requirements of this chapter.

(Reason: To accommodate buildings regulated under state law. Further clarified to mean Components that are specifically addressed by TDLR shall be exempt.)

****Section 310; Change to read as follows:**

310.1 General. Suction entrapment avoidance for pools and spas shall be provided in accordance with APSP 7 or for public swimming pools in accordance with State of Texas Rules for Public Swimming Pools and Spas, Title 25 TAC Chapter 265 Subchapter L, Rule §265.190.

[Remainder unchanged]

(Reason: To clarify specific Texas statutes which regulate public pools and spas.)

****Section 313.7; Change to read as follows:**

313.7 Emergency shutoff switch for spas and hot tubs. ~~An emergency shutoff switch shall be provided to disconnect all power to recirculation and jet system pumps and air blowers. Emergency shutoff switches shall be provided with access, located within sight of pools and spas and located not less than 5 feet (5') horizontally from the inside walls of the pool or spa. A clearly labeled emergency shutoff or control switch for the purpose of stopping the motor(s) that provide power to the recirculation system and jet system shall be installed at a point readily accessible to the users and not less than 1.5 m (5 ft.) away, adjacent to, and within sight of the spa or hot tub. This requirement shall not apply to one and two family dwellings and townhouses.~~

Exception: ~~Onground storable and permanent inground residential swimming pools.~~

(Reason: Language is from 2017 NEC Article 680.41.)

**** Section 402.12; Change to read as follows:**

402.12 Water envelopes. The minimum diving water envelopes shall be in accordance with ~~Table 402.12~~ Texas Department of State Health services, Administrative Code Title 25, Chapter 265, Section 186 (e) and Figure: 25 TAC 256.186 (e) (6). (Delete Table 402.12 and Figure 402.12)

ADD: Figure: 25 TAC §265.186 (e) (6)

Maximum Diving Board Height Over Water	¾ Meter	1 Meter	3 Meters
Max. Diving Board Length	12 ft.	16 ft.	16 ft.
Minimum Diving Board Overhang	2 ft. 6 in.	5 ft.	5 ft.
D1 Minimum	8 ft. 6 in.	11 ft. 2 in.	12 ft. 2 in.

D2 Minimum	9 ft.	10 ft. 10 in.	11 ft. 10 in.
D3 Minimum	4 ft.	6 ft.	6 ft.
L1 Minimum	4 ft.	5 ft.	5 ft.
L2 Minimum	12 ft.	16 ft. 5 in.	19 ft. 9 in.
L3 Minimum	14 ft. 10 in.	13 ft. 2 in.	13 ft. 11 in.
L4 Minimum	30 ft. 10 in.	34 ft. 7 in.	38 ft. 8 in.
L5 Minimum	8 ft.	10 ft.	13 ft.
H Minimum	16 ft.	16 ft.	16 ft.
From Plummet to Pool Wall at Side	9 ft.	10 ft.	11 ft. 6 in.
From Plummet to Adjacent Plummet	10 ft.	10 ft.	10 ft.

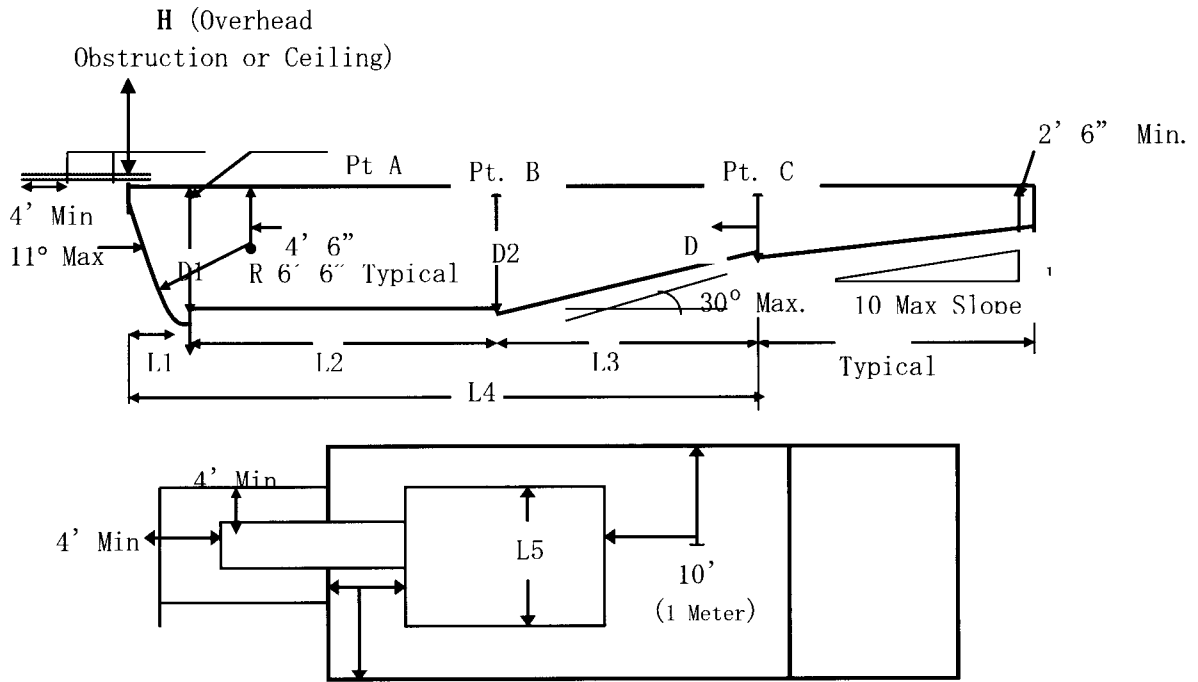

(Reason: To avoid conflict with 25 TAC Chapter 265.)

****Section 402.13; Change to read as follows:**

402.13 Ladders for diving equipment. Ladders shall be provided with two grab rails or two handrails. There shall be a uniform distance between ladder treads, with a 7 inch (178 mm minimum) distance and 12 inch (305 mm) maximum distance. Supports, platforms, steps, and ladders for diving equipment shall be designed to carry the anticipated loads. Steps and ladders shall be of corrosion-resistant material, easily cleanable and with slip-resistant tread.

Exception: The distance between treads for the top and bottom riser can vary.

(Reason: To avoid conflict with 25 TAC Chapter 265.186 (c)(8)(d).)

****Section 411.2.1 & 411.2.2; Change to read as follows:**

411.2.1 Tread dimensions and area. Treads shall have a minimum unobstructed horizontal depth (i.e., horizontal run) of 12 inches and a minimum width of 20 inches. be not be less than 24 inches (607mm) at the leading edge. Treads shall have an unobstructed surface area of not less than 240 square inches (154838mm²) and an unobstructed horizontal depth of not less than 10 inches (254 mm) at the center line.

411.2.2 Risers. Risers for steps shall have a maximum uniform height of 10 inches, with the bottom riser height allowed to taper to zero except for the bottom riser, shall have a uniform height of not greater than 12 inches (305 mm) measured at the center line. The bottom riser height is allowed to vary to the floor.

(Reason: To avoid conflict with 25 TAC Chapter 265.186 (c)(7)(A)& (B).)

****Section 411.5.1 & 411.5.2; Change to read as follows:**

411.5.1 Swimouts. Swimouts, located in either the deep or shallow area of a pool, shall comply with all of the following:

1. Unchanged
2. Unchanged
3. Unchanged
4. The leading edge shall be visibly set apart and provided with a horizontal solid or broken stripe at least 1 inch wide on the top surface along the front leading edge of each step. This stripe shall be plainly visible to persons on the pool deck. The stripe shall be a contrasting color to the background on which it is applied, and the color shall be permanent in nature and shall be a slip-resistant surface

411.5.2 Underwater seats and benches. Underwater seats and benches, whether used alone or in conjunction with pool stairs, shall comply with all of the following:

1. Unchanged
2. Unchanged
3. Unchanged
4. Unchanged
5. The leading edge shall be visually set apart and provided with a horizontal solid or broken stripe at least 1 inch wide on the top surface along the front leading edge of each step. This stripe shall be

plainly visible to persons on the pool deck. The stripe shall be a contrasting color to the background on which it is applied, and the color shall be permanent in nature and shall be a slip-resistant surface.

6. Unchanged
7. Unchanged

(Reason: To avoid conflict with 25 TAC Chapter 265.184 (u) & 265.186 (c)(10).)

****Section 603.2; Change to read as follows:**

603.2 Class D-2 pools. ~~Where a Class D-2 pool has a bather accessible depth greater than 4 1/2 feet (1372 mm), the floor shall have a distinctive marking at the 4 1/2 feet (1372 mm) water depth.~~

Class A and B pools: Class A and B pools over 5 feet deep: the transition point of the pool from the shallow area to the deep area of the pool shall be visually set apart with a 4-inch minimum width row of floor tile, a painted line, or similar means using a color contrasting with the bottom; and a rope and float line shall be provided between 1 foot and 2 feet on the shallow side of the 5-foot depth along and parallel to this depth from one side of the pool to the other side. The floats shall be spaced at not greater than 7-

foot intervals; and the floats shall be secured so they will not slide or bunch up. The stretched float line shall be of sufficient size and strength to offer a good handhold and support loads normally imposed by users. If the owner or operator of the pool knows or should have known in the exercise of ordinary care that a rope or float is missing, broken, or defective, the problem shall be promptly remedied

(Reason: To avoid conflict with 25 TAC Chapter 265.199.)

****Section 610.5.1; Change to read:**

610.5.1 Uniform height of 9-10 inches. Except for the bottom riser, risers at the centerline shall have a maximum uniform height of 9-10 inches (229-254 mm). The bottom riser height shall be permitted to vary from the other risers.

(Reason: To avoid conflict with 25 TAC Chapter 265.186 (c)(7)(B).)

*****Section 804 Diving Water Envelopes; Change to read as follows:**

Section 804.1 General. The minimum diving water envelopes shall be in accordance with Table 804.1 and Figure 804.1, or the manufacturer's specifications, whichever is greater. Negative construction tolerances shall not be applied to the dimensions of the minimum diving water envelopes given in Table 804.1.

(Reason: To provide minimum standards and to clarify specific manufactures specifications of the diving equipment.)

END